

p.c.b. layout

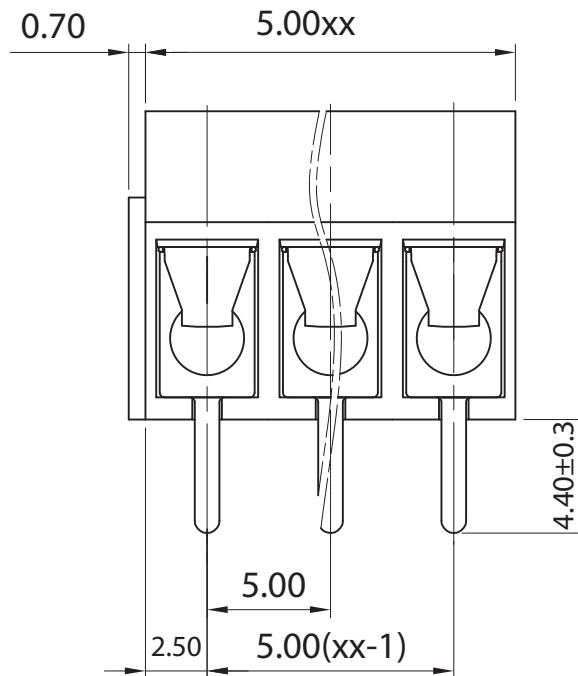

Approvals

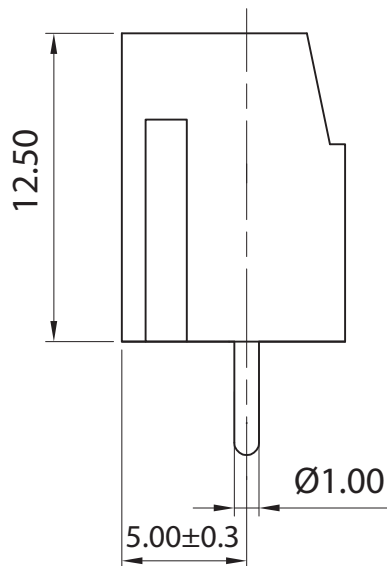
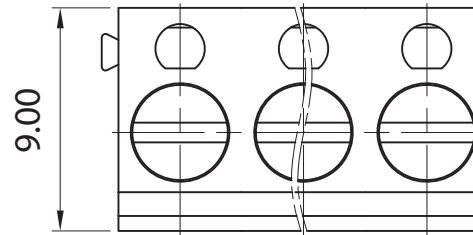

16A -250V

Electrical

Rated voltage 250V
 Rated current 17.5A
 Contact resistance 20mΩ
 Insulation resistance 500MΩ/DC500V
 Impulse voltage 1.6KV
 Wire range 1,5mm2 22÷16 AWG

Torque 0,5Nm (4.5Lb In)
 Temp. Range -40°C + 105°C
 Stripping length 5 mm
 Max sold. time +250°C for 5 sec.

Dimensions

Pitch 5 mm
 Poles 2÷24

Material

Housing PBT UL94V0
 Pin Copper Alloy, Sn plated
 Cage Copper Alloy, Ni plated
 Screws M3; Steel Zn plated
 Side Block ---
 Nut screw ---
 Clamp ---

General description of ordering code

Series	n. Poles	Pitch	Version	Color	Custom
MLT52	2÷24	-5	-V		

Version Date

01/22 27/04/2022



euro-block



UNITS: mm

SHEET SIZE: ISO A4

SCALE: 4:1

> 0 ~ 3

> 3 ~ 18

> 18 ~ 50

> 50 ~ 120

± 0.12

± 0.15

± 0.3

± 0.5



First angle projection

MLT52-5-V